



RIVETKING®

PRODUCT LINE

RIVETS • PNEUDRAULICS • PNEUMATICS • CORDLESS • AUTOFEED • HAND TOOLS

FOR PROFESSIONAL INSTALLATION OF:

- BLIND RIVETS
- RIVETNUTS
- LOCKBOLTS
- QUICKRIVETING
- SEMI-TUBULAR RIVETS
- QUICKRIVETING
- SOLID RIVETS



DISTRIBUTED BY:

WWW.RIVETKING.COM



The RivetKing® Product Line

A FAMILY OWNED 4TH GENERATION COMPANY WITH 103 YEARS IN BUSINESS AND WITH 10 INTERNATIONAL LOCATIONS, 9 US DISTRIBUTION CENTERS AND 70 EMPLOYEES STATESIDE. INDUSTRIAL RIVET IS UNIQUELY POSITIONED TO DELIVER A SUPERIOR AND INNOVATIVE PRODUCT LINE BACKED BY EXEMPLARY SERVICE AND UNMATCHED QUALITY.

NORTH AMERICA

USA	Northvale, Burlington, Santa Fe Springs, Denver, Kansas City, El Paso, Grand Prarie, Chicago,	New Jersey N. Carolina California Colorado Missouri Texas Texas Illinois
Canada	Missassauga	
Mexico	Monterey	

Pacific Rim Kaoshiung, Taiwan • Shanghai, China • Shibuya, Japan
Perth, Australia

Europe Neumarkt, Germany, Spain, & United Kingdom

A SUPERIOR, ROBUST PRODUCT SET

Industrial Rivet has one of the largest inventories of off the shelf products that range from standard to highly specialized rivets, available in any head style, length, material and finish, including:

- Blind Rivets
- Solid Rivets
- Speed Rivets
- Semi-Tubular Rivets
- Rivet Nuts
- Split Rivets
- Drive Rivets
- Collar Rivets
- Lock Bolts
- Shoulder Rivets

We have approximately 3000 pallet positions which equates to billions of rivets in inventory, ready for same day shipment.



FORCE TESTING
IFI135 & ISO 14589



SALT SPRAY TESTING
ASTMB117-07A & ISO 9227

WE ARE HERE FOR YOU

OUR TRAINED PERSONNEL ARE HERE TO SERVE OUR CUSTOMERS. IF YOU HAVE ANY QUESTIONS, PLEASE CALL OUR QUALITY CONTROL DEPARTMENT OR ONE OF OUR APPLICATIONS ENGINEERS. TAP INTO OUR CAPABILITIES, WE'RE HERE TO SERVE YOU.

INDUSTRIAL RIVET & FASTENER CO.
200 PARIS AVENUE
NORTHVALE, NEW JERSEY 07647
U.S.A.
TEL: (201) 750-1040 1-800-BUY-RIVET
FAX: (201) 750-1050
WWW.RIVET.COM



TECHNICAL SUPPORT

Technical Support is provided on all RivetKing products. At your disposal you will find application engineers, quality engineers, and a knowledgeable sales associate to help you along the way. Whether its testing, product selection, or you need to help your customer repair their rivet gun, we are here to help you earn your reputation as we aim to earn ours.

ENGINEERING

We challenge you to find us a riveting problem we can't solve. Our engineers will conduct an indepth evaluation of your customers application and make recommendations on how it can be improved and automated, all while offering an installed cost savings. This offers our distributors great opportunities for print position on the engineered sale. Sales Drawings are always openly shared in either 2D or 3D format.

QUALITY CONTROL

Delivering the right product and at the right time is important, but to Industrial Rivet it is only part of the equation. Since rivets are permanent, they must be of the highest quality, which is why the company uses an advanced computerized quality control system to inspect each and every one of its products in terms of both consistency and reliability.

Additional quality control systems are in place for specific products such as the company's Salt Spray chamber that confirms the effectiveness and longevity of plated material in an accelerated corrosive environment. Shear, tensile and break load testing is also performed onsite regularly to gauge the structural integrity of each inspected product.

As a result, Industrial Rivet as a whole has been ISO certified for more than a decade and many of the company's manufacturing facilities are also TS16949 accredited. The company is also currently in the process of obtaining A2LA accreditation.

Production Tools - Features and Capacities

RIVETKING® TOOLS FOR BLIND RIVETS

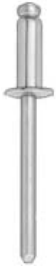

MODEL		3/32"	1/8"	5/32"	3/16"	1/4"	LIGHT DUTY	HIGH PERFORMANCE	HEAVY DUTY	MRO / EXPENDABLE	VACUUM MANDREL COLLECTION	BUCKET COLLECTION OPTION	AUTOFEED	CORDLESS	LCD DISPLAY OPTION	WIFI OPTION	FORCE SENSOR OPTION	ERGONOMIC	ADVANCED ERGONOMICS	SHOCK RESISTANT	LIGHTWEIGHT	BODY BOOT PROTECTION	CARRY CASE & TOOL ORGANIZER	3 JAW DESIGN	ADJUSTABLE AIR INLET	QUICK CLEAN JAW SYSTEM	6 MONTH WARRANTY	12 MONTH WARRANTY	24 MONTH WARRANTY	EXTENDED WARRANTY
ECONOMY TOOLS	RK-187	●	●	●	●				●	●																				
	RK-250			●	●				●	●																	●			
	RK-400CR		●	●	●	●				●				●													●			
RK-8000 SERIES	RK-8000S	●	●	●				●			●	○						●		●	●		●	●		○				
	RK-8000M		●	●	●			●			●	○						●		●	●		●	●		○				
	RK-8000LS			●	●	●		●			●	○						●		●	●		●	●		○				
RK-9000 SERIES	RK-9000S	●	●	●				●	●		●							●	●	●	●	●		●	●				●	○
	RK-9000M		●	●	●			●	●		●							●	●	●	●	●		●	●				●	○
	RK-9000LS			●	●	●		●	●		●							●	●	●	●	●		●	●				●	○
FREESET® SERIES	RK-777		○	●	●	●	●				○		●	○	○	○	●		●				●		●			●		○
KINGSET® SERIES	RK-4500KS5		●	●			●				●	○	●					●	●	●	●		●		●			●		○

RIVETKING® TOOLS FOR RIVET NUTS



MODEL		#6-32 (M3)	#8-32 (M4)	#10-32 (M5)	1/4-20" (M6)	5/16-18" (M8)	3/8-16" (M10)	1/2-13" (M12)	SET TO STALL	SET TO STROKE	SET TO PRESSURE	SET TO FORCE	1 BUTTON TRIGGER	2 BUTTON TRIGGER	AUTO REVERSE	LCD DISPLAY	WIFI OPTION	FORCE SENSOR OPTION	BARCODE SETUP	PROGRAMMABLE	ERGONOMIC	ADVANCED ERGONOMICS	QUICKCHANGE SYSTEM (TOOLESS)	BODY BOOT PROTECTION	CARRY CASE & TOOL ORGANIZER	ADJUSTABLE AIR INLET	CORDLESS	12 MONTH WARRANTY	24 MONTH WARRANTY	EXTENDED WARRANTY		
SPIN-SPIN SERIES	RK-1500Q		●	●	●				●					●							●		●									
	RK-500Q				●	●			●					●							●		●									
	RK-280						●	●	●					●							●		●									
SPIN-PULL SERIES	RK-50SP	●	●	●	●	●	●	△			●		●		●						●		●	△	●				●		○	
	RK-55SPS	●	●	●	●	●	●	●		●			●		●						●		●	●	●	●			●		○	
FREESET® SERIES	RK-787	●	●	●	●	●	△		●	●	○	●		●	●	○	○	○	○	●	●		●			●		●		○		

RIVETKING® TOOLS FOR LOCKBOLTS



MODEL		3/16" (4.8MM)	1/4" (6.4MM)	5/16" (8.0MM)	3/8" (10MM)	SET TO FORCE	PINTAIL COLLECTION CUP	LCD DISPLAY	WIFI OPTION	FORCE SENSOR OPTION	BARCODE SETUP	PROGRAMMABLE	ERGONOMIC	CORDLESS	12 MONTH WARRANTY	24 MONTH WARRANTY	EXTENDED WARRANTY
PNEUDRAULIC TOOL	RK-756	●	●	●	●												
FREESET® SERIES	RK-797	●	●			●	●	●	●	●	●	●	●	●	●	●	○

● STANDARD FEATURE ○ OPTIONAL FEATURE △ LIMITATIONS (CONTACT SALES)

Blind Rivet Tools — High Performance

RK-9000 SERIES - 2 Year Limited Warranty - Managed Maintenance

ROBUST, HIGH PERFORMANCE RIVETING - MAINTAINED BY PROFESSIONALS.

The fusion of power and speed, with an improved ergonomic and rugged design results in a series of tools for the most demanding production environments. The RK-9000 series offers a 360° degree adjustable air inlet for both left and right handed users. The vacuum forces is greatly improved due to its efficient use of air providing extreme extraction of the mandrel after riveting. The easy touch trigger requires less than .25 lbs force to activate. The rugged glass filled nylon casing and high durometer rubber boot provides the tool with years of protection. All tools are serialized for tracking. Only care and cleaning is required of the users. Maintenance is supported by service centers nationwide.

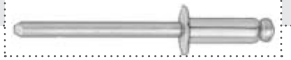

MODEL# RK-9000-S
3/32"* , 1/8" , 5/32" , 3/16"*
Power: 1,640 lbF
Stroke: .670"
Weight: 2.75 lbs
Size: 10.3" x 10.7" x 3.89"



MODEL# RK-9000-M
1/8" , 5/32" , 3/16"
Power: 2,800 lbF
Stroke: .825"
Weight: 3.63 lbs
Size: 10.8" x 10.7" x 3.93"



MODEL# RK-9000-LS
3/16" , 1/4" Structural
Power: 3,600 lbF
Stroke: 1.00"
Weight: 3.96 lbs
Size: 10.8" x 10.7" x 3.93"

RK-8000 SERIES - 1 Year Limited Warranty - User Maintenance

MODULAR DESIGN AND A CARRY CASE - MAINTAINED BY USERS.

The proven RK-8000 series was designed on a modular platform which allows for backwards compatibility across revisions. The three models have many interchangeable parts and there is swift access to the internal components. The long stroke insures the rivet is set in one shot. The vacuum mandrel collection system is adjustable to reduce the load on shop compressors. The tool is provided in a blow molded case with organizational foam inserts for companies developing 5-S strategies. All tools are serialized for tracking. This series can be supported in-house with the provided tool kit or with standard tools available in any maintenance department.



MODEL# RK-8000-S
3/32"* , 1/8" , 5/32" , 3/16"*
Power: 1,800 lbF
Stroke: .787"
Weight: 2.42 lbs
Size: 11.5" x 11.0" x 4.0"



MODEL# RK-8000-M
1/8" , 5/32" , 3/16"
Power: 2,450 lbF
Stroke: .787"
Weight: 3.30 lbs
Size: 12.0" x 11.0" x 4.0"



MODEL# RK-8000-LS
1/8" , 5/32" , 3/16"
Power: 3,400 lbF
Stroke: 1.00"
Weight: 3.96 lbs
Size: 12.0" x 12.5" x 4.0"

KINGSET - Autofeed Riveting System

THE ABSOLUTE FASTEST AND MOST COST EFFECTIVE AUTOFEED RIVETING SOLUTION.

Streamline your process and eliminate wasted time. STOP loading rivets one by one. Operators can now focus on hole alignment rather than picking the rivet from a box and placing the rivet in the nose piece. With the Kingset system, rivets are supplied on PE film which is fed through the nose of the riveter. Once the rivet is set, the next is autofed to the nose. The system reduces operator fatigue and significantly improves output. Ask us and we will prove it by a free demonstration at your facility.



MODEL#	CAPACITY
RK-4500-KS5	1/8" , 5/32"
RK-4500-KS6	3/16"



RK-777 FREESSET -

High Performance Cordless Riveting

INCREASED WORK AREA SAFETY AND QUALITY CONTROL.

The Freeset series is an industry changing alternative to pneumatics. For the first time in cordless tools, the brushless motor is capable of setting rivets faster than traditional air riveters. In todays competitive environment, the costs for maintenance of compressed air systems are being realized. Work areas are more condensed causing an increase in trip and fall accidents. A tool free of air, cords and attachments is now possible with Freeset. The tool can also be optionally equipped with bar code readers, force sensors and WIFI to insure each rivet is properly installed.



MODEL#	CAPACITY
RK-777	BLIND RIVETS
RK-787	RIVET NUTS
RK-797	LOCK BOLTS



ERROR PROOFING CAPABILITIES



BARCODE READER



WIFI



RivetNut Tools - High Performance

PNEUDRAULIC SPIN-PULL TOOLS FOR RIVETNUTS

SPIN/PULL TO PRESSURE - PERFORMANCE AND VERSATILITY

The RK-50SP is a proven and cost effective alternative to spin-spin models. With Pneudraulic technology, you can apply rivetnuts with speed and consistency improving overall quality of the riveted components.



RK-50-SP 1/2" MAX
M12 MAX

Power: 6,565 lbsF
 Stroke: .276"
 Weight: 5.5 lbs

SPIN/PULL TO STROKE - LIGHTWEIGHT, POWERFUL AND ERGONOMIC

The RK-55SPs has the highest force to weight ratio in its class. Powerful, yet extremely lightweight, it is ideal for production lines where repetitive motion is of concern. The tools shell is well protected to prevent damage from accidental droppage. 360° degree air Inlet is well suited for right handed or left handed users.



RK-55-SPS 1/2" MAX
M12 MAX

Power: 4,158 lbsF
 Stroke: .276"
 Weight: 3.3 lbs

CORDLESS FREESET® SPIN-PULL TOOL FOR RIVETNUT

RK-787 3/8" MAX

SPIN/PULL TO FORCE OR SPIN/PULL TO STROKE —YOU CHOOSE!—

The Freetset RK-787 is absolutely the most advanced riveter available today. It is the only tool available with a load cell on the nose assembly to insure that the force generated by the tool is actually delivered to the rivet nut. This eliminates rivet nut spin outs completely and insures the rivet nut is properly set, every time. Simply program the force needed for the desired rivet nut. For quick and easy program setup, a barcode readers can be optionally installed.

OPTIONS:
 USB Access, Freetset Manager Software, Barcode Reader, Speed Control, WIFI, PLC Integration



SEE PAGE 6 FOR MORE INFO

RivetKing® LockBolt Tools

COLLAR BOLT INSTALLATION TOOLS- Collar Bolts & Tools for Collar Bolts larger than 3/8" Diameter are available on request.

RK-797 1/4" MAX



SEE PAGE 6 FOR MORE INFO

RK-756 3/8" MAX



RK-BCS BUCKET COLLECTION SYSTEM

The bucket collection system comes integrated with a high power pneumatic vacuum which is attached via a small hose in place of the mandrel collection cup. It will withdraw spent mandrels up to 10 feet away from the RK-8000 riveter.





RivetKing® QuickRiveting

QUICKRIVETING SYSTEM®

Rivets are provided on magazines called pods with up to 80 rivets on a pod. Pods are easily loaded into a lightweight 3lb riveting handle for installation of up to 1 rivet per second. Rivets are installed by the withdrawal of a re-usable mandrel and radially expanding the entire body of the rivet. Because the mandrel is completely withdrawn there is no mandrel waste on the assembly floor. Perfect for electronics applications.

ADDITIONAL ADDED VALUE FEATURES INCLUDE:

- Increased Output
- Reduced Labor
- Minimal Waste
- Improved Ergonomics
- Cost Savings
- Improved Joint Quality and Performance
- Fine Tuning and Flexibility
- Reliability and Consistency



RK-753 STANDARD MODEL



RK-753-T
TOP MOUNT MODEL



RK-753-I
STANDALONE RIVETING TOOL



RK-753-P3
PANTOGRAPH RIVETING TOOL

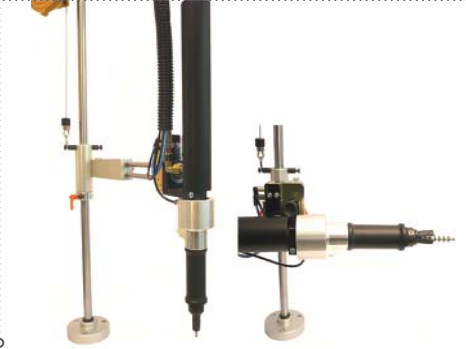

RivetKing® Automation



KINGSET™ – A REVOLUTIONARY RIVET DELIVERY SYSTEM

KINGSET™ IS A SOPHISTICATED HANDHELD RIVETING SYSTEM OFFERING USERS A TRULY UNPRECEDENTED LEVEL OF FUNCTIONALITY.

With auto-feed capabilities – KingSet™ can literally be used to set any type of 1/8", 5/32" and 3/16" breakstem blind rivet pre-loaded on tape. And since KingSet™ has been engineered and designed for different application ranges, it can easily adapt to a variety of manufacturing environments.

The incredible flexibility of our best-in-class rivet delivery system also provides a fast setting operation that includes rapid reload and cycle times. The result is an immediate increase in productivity and significant cost savings with the reduction of in-place installation. For even greater efficiency, an adjustable vacuum system minimizes air consumption based specifically on the size of the rivet being set.

KingSet™ is a fully portable, ergonomically balanced tool that can be suspended either horizontally or vertically. This is combined with a highly engineered, one-touch operation that allows users to set rivets automatically while leaving one hand free to hold work pieces in place. Plus, a built-in Mandrel Collection System (MCS) helps insure work place safety and cleanliness.

Perfect for mid-range to high volume applications, KingSet™ provides a strong, reliable joint while effectively streamlining the assembly of everything from appliances, to automotive products, to electronic chassis, to HVAC and other sheet metal fabrications.



KINGSET™ STREAMLINES THE ASSEMBLY

Sheet Metal Fabrications Including Appliances, Automotive Products, Signage, and More.



SERVICE AND SUPPORT



With eight international locations, ten U.S. distribution centers, and nearly seventy employees – RivetKing® is uniquely positioned to deliver a superior and innovative product set backed by exemplary service and unmatched quality.

When you choose KingSet™, our Application Engineers will conduct an in-depth evaluation of your operations and make recommendations on how this automated, handheld tool can best work in your environment. In addition, our experts are always available by phone or on site to provide technical support for any product; even another manufacturer's current and past rivet delivery systems.

Simply put, KingSet™ gives you all the reliability you are used to, but with a far greater range of applications and with the ability to use our self-feed riveting system with any manufacturer's rivets.

RIVETKING® FOR EVERYTHING YOU NEED

As a world-class manufacturer, distributor and importer – RivetKing® gives you access to the industry's deepest inventory of ready-made rivets. Our extensive knowledge of permanent fasteners and vast manufacturing network also means we can make custom products in any head style, length, material and finish, including:

- BLIND RIVETS
- SPEED RIVETS
- RIVET NUTS
- SOLID RIVETS
- SEMI-TUBULAR RIVETS
- SPLIT RIVETS
- SHOULDER RIVETS
- COLLAR RIVETS
- DRIVE RIVETS
- LOCKBOLTS

All this is combined with a wide array of innovative rivet delivery systems, including our ground breaking KingSet™ handheld tool.

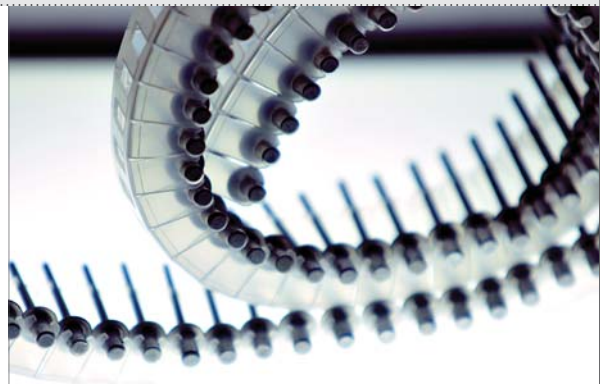

FREESSET™ – FAST, CORDLESS, INTELLIGENT RIVETING TOOLS

FREESSET™ IS A GROUND BREAKING TECHNOLOGY WHICH OFFERS THE FREEDOM OF BATTERY OPERATED TOOLS AND COMBINES IT WITH SMART TECHNOLOGIES TO PROVIDE AN INTERACTIVE RIVETING EXPERIENCE.

Its concept is simple: Add intelligence to a high performance tool, with a renewable energy source and you arrive with the technology of FreeSet. FreeSet is a tool offered in a variety of configurations which can meet and exceed the needs of its users. Whether operating without access to a compressor, de-cluttering work cells, or incorporating error-proofing strategies in the production line, FreeSet can be configured to solve nearly any assembly problem.

FreeSet Technology can be used to apply Blind Rivets, Rivet Nuts or LockBolts and can be configured as a LITE, STANDARD, or PRO version.

The PRO version error proofing features are robust, providing both visual and audible OK/NO-OK indicators via the multi color display.

The force sensor can detect variations in setting force as well as the actual grip. The results of which can either be stored in the tool memory card, or exported by USB to EXCEL to review the force curves.

A barcode reader can be added for quick and easy program recall and tool setup.

For advanced users, a WIFI connection can be opened and the tool can communicate with PLC for additional controls.

This tool is ECO Friendly and considered a Green technology as the battery life is managed by the tools microprocessor and the smart charger. This extends battery life for years. In addition, this tool can be used in calculations to reduce your CO2 foot print.



VERSIONS

ALL VERSIONS:

- 18V up to (7.5Ah) 3 Battery with Battery Management System
- High Power Brushless Motor
- Work light
- Maintenance Management System
- Maintenance Interval Alarm / Buzzer

(-1) LITE VERSION:

- Without Multi color Display and without Optional Features

(-2) STANDARD VERSION:

- Multi Color Display, USB Connectivity, Software, Motor Control
- Optional Features: Barcode Reader, WiFi

(-3) PRO VERSION:

- Force Sensor, Rivet Qualifier, Operator Feedback, Memory Card, Counter
- Storage of up to 150,000 rivet installations
- Multi Color Display USB Connectivity, Software, Motor Control
- Optional Features: Barcode Reader, WiFi

FREESSET® BENEFITS

SAFER WORK ENVIRONMENT

- Eliminate Trip Hazards
- Improved Ergonomics, no cable to drag around
- Improved Air Quality, eliminating oil emitted from the air

REDUCE MANUFACTURING COSTS

- Quick Draw Technology drastically increases tool speed
- Cordless Tools use 99% less energy than air tools
- No pressure drops caused by compressors
- No Maintenance of oilers
- No more supply line leaks
- Portable and can be re purposed
- Eco/Green Friendly - Reduces CO2 footprint

QUALITY ASSURANCE

- Break Load/Installation Force Measurement
- Error Proofing features with visual and audible alerts
- Data logging and access via Excel
- Increased operator/supervisor awareness
- Increased supervisor or engineering
- No cords to dirty or scratch painted or finished surfaces
- Test and compare batches of rivets
- Test tightness and set to a specific setting force
- Ensures the correct number of rivets has been installed

RK-777 FOR BLIND RIVETS

MODELS:

- RK-777-1, LITE, No Display
- RK-777-3, PRO, Force Sensor



OPTIONS:

- USB
- BARCODE READER
- WIFI
- STRUCTURAL VERSIONS

CAPACITY:

- 1/4"
- 2,900 LBS MAX

RK-787 FOR RIVET NUTS

MODELS:

- RK-787-2, STD, Force Only
- RK-787-3, PRO, Force/Stroke Sensor



Pull to Force
Pull to Stroke
Pull to Press/Volt

OPTIONS:

- USB
- BARCODE READER
- WIFI

CAPACITY:

- 3/8" THINWALL
- 4,000 LBS MAX

RK-797 FOR LOCKBOLTS

MODELS:

- RK-787-1, LITE, No Display
- RK-787-3, PRO, Force/Stroke Sensor



OPTIONS:

- USB
- BARCODE READER
- WIFI

CAPACITY:

- 1/4"
- 2,900 LBS MAX

BLIND RIVETING TOOLS

RK-65	3/16" MAX. NOSEPIECES ONBOARD
--------------	--

RK-65 BLIND RIVETING TOOL	
PART NUMBER	DESCRIPTION
RK65	BOX PACKAGING
RK65-A	KIT W/ALUMINUM RIVETS
RK65-S	KIT W/STEEL RIVETS
RK65-F	KIT W/STAINLESS RIVETS



RK-69	3/16" MAX. NOSEPIECES ONBOARD
--------------	--



CN-6B	3/16" MAX. NOSEPIECES ONBOARD
--------------	--





RK-92	3/16" MAX. NOSEPIECES ONBOARD
--------------	--



RK-93	3/16" MAX. NOSEPIECES ONBOARD
--------------	--

COINED AS THE BIG MAMMA, THIS GEARED RIVETING TOOL HAS EXTREME MECHANICAL ADVANTAGE AND CAN SET EVEN STRUCTURAL RIVETS WITH EASE DUE TO ITS LONG STROKE AND HIGH POWER. THE HANDLES ARE DESIGNED TO PROVIDE THE USER WITH EXTREME LEVERAGE IN DEMANDING APPLICATIONS

RIVETKING® COMBO TOOLS, 2-IN-1 BLIND RIVET & RIVET NUT TOOL

WHY BUY TWO TOOLS WHEN YOU ONLY NEED ONE?
This unique tool has the ability to set both blind rivets and rivetnuts. The changeover from blind rivets to rivet nuts is simple and takes less than 1 minute. The tool is supplied in kit form, and contains a nose piece for blind rivets and mandrels for rivetnuts in every size and is conveniently stored in the blow molded carry case. Forged steel arms ensure durability while comfort soft touch rubberized grips guarantee comfort.

RK-20	BLIND RIVETS = 3/32", 1/8", 5/32", 3/16" NUTS = #6-32, #8-32, #10-32, 1/4-20"
--------------	--



CONVERTS FROM BLIND RIVETS TO RIVET NUTS



RK-20 BLIND RIVETING TOOL	
PART #	DESCRIPTION
RK20	INCH TOOL - BOX PACKAGING
RK20M	METRIC TOOL - BOX PACKAGING
RK20_-AKIT	KIT W/ ALU RIVETS & NUTS
RK20_-SKIT	KIT W/ STEEL RIVETS & NUT
RK20_-FKIT	KIT W/STAINLESS RIVETS & NUTS
RK20_-MKIT	KIT W/STAINLESS RIVETS & NUTS



WHY BUY TWO TOOLS WHEN YOU ONLY NEED ONE?
This unique tool has the ability to set both blind rivets and rivetnuts. It even has the ability to set 1/4" structural blind rivets and rivetnuts up to 3/8". The changeover from blind rivets to rivet nuts is simple and takes less than 1 minute. It's patented fold away design makes it easy to carry and store. It contains a nose piece for blind rivets and mandrels for rivetnuts in every size and is conveniently stored in the blow molded carry case. Forged steel arms ensure durability while comfort soft touch rubberized grips guarantee comfort.

RK-21	BLIND RIVETS = 1/4" & STRUCTURAL RIVET NUTS = 3/8" OR 10MM
--------------	---



MANUAL RIVETNUT™ TOOLS

RK-100 RIVETNUT TOOLS	
PART NUMBER	DESCRIPTION
RK100	BOX PACKAGING
RK100-AK	KIT W/ALUMINUM RIVETS
RK100-SK	KIT W/STEEL RIVETS
RK100-3K	KIT W/STAINLESS RIVETS

RK-100 1/4-20"
6MM MAX.



RK-22 6-32"~1/2-13"
M3 ~ M12



RK-23 6-32"~5/16-18"
M3 ~ M8



RK-24 6-32"~1/2-13"
M3 ~ M12



RK-28C 6-32"~1/2-13"
M3 ~ M12



CN12 1/4-20" MAX.



RIVETKING® 2 IN 1- BLIND RIVET & RIVET NUT TOOL

WHY BUY TWO TOOLS WHEN YOU ONLY NEED ONE?

This unique tool has the ability to set both blind rivets and rivetnuts. It even has the ability to set 1/4" structural blind rivets and rivetnuts up to 3/8". The changeover from blind rivets to rivet nuts is simple and takes less than 1 minute. It's patented fold away design makes it easy to carry and store. It contains a nose piece for blind rivets and mandrels for rivetnuts in every size and is conveniently stored in the blow molded carry case. Forged Steel arms insure durability while comfort soft touch rubberized grips guarantee comfort.

RK-20 BLIND RIVETS = 3/16"
NUTS = 1/4-20"



RK-21 BLIND RIVETS = 1/4" & STRUCTURAL RIVETS
NUTS = 3/8" OR 10MM



CONVERTS FROM
BLIND RIVETS TO
RIVET NUTS



RK SERIES RIVETKING® ECONOLINE™ TOOLS

BUILT WITH QUALITY AND ECONOMY IN MIND, THE RK SERIES RIVETERS HAVE ENOUGH FORCE TO PULL ANY RIVET.

Perfect for DIY market and for situations where abuse or theft is of concern. The RK-6000VS is an ergonomic and lightweight model that has Vacuum Mandrel collection and is a break-away from the traditional design.

RK-187 3/16" MAX.

Power: 1,980 lbsF
Stroke: .625"
Weight: 3.3 lbs



RK-250 1/4" MAX.
& STRUCTURALS

Power: 4,200 lbsF
Stroke: .687"
Weight: 4.3 lbs



RK-6000VS ERGONOMIC MODEL

Power: 2,248 lbsF
Stroke: .669"
Weight: 4.1 lbs



RK-INLINE 3/16" MAX.

Power: 1,980 lbsF
Stroke: .625"
Weight: 3.3 lbs





RK-401CR 1/4" MAX.

Power: 1,980 lbsF
Stroke: .625"
Weight: 3.3 lbs



RivetKing® Blind Rivet / Lockbolt Product Line



STANDARD BLIND RIVETS

OPEN END	CLOSED END
 <p>ALL ALUMINUM - ABA ALUMINUM / STEEL - ABS</p> <p>ALL STEEL - SBS STAINLESS STEEL / STEEL - FBS</p> <p>ALL STAINLESS - FBF</p> <p>COPPER / BRASS - CBB BRASS - CBB</p> <p>COPPER / STEEL - CBS COPPER PLATED MANDREL</p>	 <p>ALL ALUMINUM - ABA-CE</p> <p>ALL STEEL - ABS-CE ALL STEEL - SBS-CE</p> <p>ALL STAINLESS - FBF</p>

ALL PRODUCTS ARE AVAILABLE IN:

- DOME HEAD
- C/SUNK HEAD
- LARGE FLANGE





MULTIGRIP™ BLIND RIVETS

MULTIGRIP-RT™	MULTIGRIP-CT™
 <p>ALL ALUMINUM - ABA-RT ALL STEEL - ABS-RT ALL STEEL - SBS-RT</p> <p>ALL STAINLESS STEEL - FBF-RT</p>	 <p>ALL STEEL - ABS-RT ALL STEEL - SBS-RT</p> <p>ALL STAINLESS STEEL - FBF-RT</p>

SEMI-STRUCTURAL BLIND RIVETS

RKQ®	RIVEX®	RIVINOX®	RIVIBULB®	CHECKMATE® 2PCS	TRI-FIX (TRI-FOLDING) & SUPERTRIFIX™	PLASTIC TRIFIX® RIVETS
 <p>ALL ALUMINUM - ABQ ALL STEEL - SBO ALL STAINLESS - FBQ</p>	 <p>ALL ALUMINUM - SBS-RVX ALL STEEL - ABA-RVX ALL STAINLESS - FBF-RVX</p>	 <p>ALL STAINLESS - FBF-RVINOX</p>	 <p>ALL STEEL - SBS-RVB</p>	 <p>ALL ALUMINUM - ABACM ALL STEEL - SBS-CM ALUMINUM / STEEL - ABS-CM</p>	 <p>ALL ALUMINUM - ABL</p> <p>LARGE FLANGE - ABL-LF16</p> <p>ALL ALUMINUM - ABL-STFX (STRUCTURAL) SUPERTRIFIX</p>	 <p>RECTANGLE</p> <p>PROTRUDING</p> <p>COUNTERSUNK</p>





SPECIAL BLIND RIVETS

GROOVED™	PLR™ RIVET	QUICKSNAP®	LONG LENGTH RIVET	DRIVE RIVETS
 <p>ALUMINUM / STEEL - ABS-GROOVED</p>	 <p>ALL STEEL - ABS-PLR</p>	 <p>BRASS, NICKEL PLATED RIVET STAINLESS STEEL MANDREL - BSSH</p>	 <p>ALUMINUM / STEEL - ABS-LONGLENGTH</p>	 <p>ALL MATERIALS - DR</p>

TRADE NAME CROSS REFERENCE CHART

RIVETKING®	AVDEL®	POP®	HUCK®	MARSON®	GESIPA®
MultiGripCT™	Avex®	Peel	-	MultiGrip™	PolyGrip®
MultiGripRT™	-	-	-	-	-
TriFix™	Bulbex®	LSH®	Tri-Bulb™	-	TriFold
SuperTriFix™	TLR®	-	Magna-Tite™	-	BulbTite®
Checkmate®	Cherrymate™	-	-	-	-
Tigerbolt®	MonoBolt®	-	-	-	-
In-Lock®	Interlock®	UltraGrip®	Magna-lok™	Klik-Lock™	MegaGrip®
StemLock™	Hemlok®	-	Auto-Bulb™	-	-
Rivex®	Stavex®	-	-	-	-
Rivinox®	Avinox®	-	-	-	-
Rivibulb®	AviBulb®	-	-	-	-

STRUCTURAL BLIND RIVETS

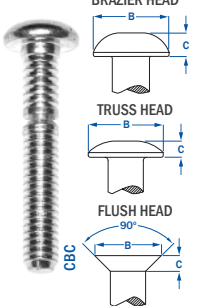
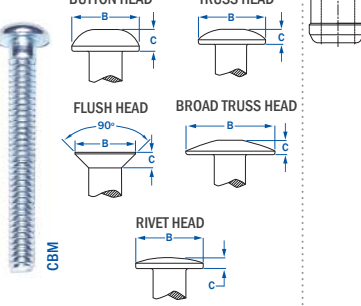
TIGERBOLT®	IN-LOCK®	STEMLOCK®	RIVBOLT™	COLLAR BOLT FIXED GRIP	COLLAR BOLT MULTI GRIP
 <p>ALL STEEL - SBS-TB</p> <p>ALL STAINLESS - FBF-TB</p> <p>COUNTERSUNK - SCS-TB</p> <p>ALL ALUMINUM - ABA-TB</p>	 <p>ALL ALUMINUM - ABS-STR</p> <p>ALL STEEL - SBS-STR</p> <p>ALL STAINLESS - FBF-STR</p>	 <p>ALL STEEL - STM ALL ALUMINUM - STMA</p>	 <p>ALL STEEL - RB</p>	 <p>BRAZIER HEAD</p> <p>TRUSS HEAD</p> <p>FLUSH HEAD</p> <p>CBC</p>	 <p>BUTTON HEAD</p> <p>TRUSS HEAD</p> <p>FLUSH HEAD</p> <p>BROAD TRUSS HEAD</p> <p>RIVET HEAD</p> <p>CBM</p>

LSR LOAD® SPREADING, PEEL RIVET®, WELL-NUT®, ULTRAGRIP®, GROOVED RIVETS, JACK-NUT®, HR RIVET®, EASY ENTRY®, POPNUT®, SOFT SET®, CLOSED END, PROSET®, MULTIGRIP™, OPEN END, PRG SERIES, POPMATIC RIVET TOOLS® ARE REGISTERED TRADEMARKS OF POP® EINHART FASTENING TECHNOLOGIES, INDUSTRIAL DIVISION, A BLACK & DECKER COMPANY. GRIPRITE, OPEN END, CLOSED END, MULTI-GRIP®, TRI-BULB®, KLIK-LOCK®, MAGNATITE®, C&G®, KLIKRIKET NUTS®, MAGNALOK®, CSOL®, KLIK-SERTS/POLYNUTS®, AUTO-BULK/MANABULB®, C120L®, 302E / 304E, STRONGHOLD™, MAGNAGRIP®, M SERIES, AUTOCLAMP®, BOM RIVET®, V SERIES, PEEL®, HUCKTAINER®, KLIK-FAST®, FLOORITTE, FI SERIES ARE REGISTERED TRADEMARKS OF HUCK® - MARSON®, ALCOA FASTENING SYSTEMS. AVEX®, AVIBULB®, AVINOX®, SUPERSERT®, BULBEX®, EARTHAB RIVET, GENESIS TOOLS®, KLAMPITTE®/TLR, BRIV®, AVDEL SPEED FASTENING®, MONOBOLT®, RIVSCREW®, SR RIVET, HEMLOK®, GROVIT®, Q-RIVET®, STAVEX®, CHERRYMATE®, AVTRONIC®, AVEDELOK®, MAXLOK®, CAMTAINER®, VERSANUT® ARE REGISTERED TRADEMARKS OF AVDEL®, ACUMENT™ GLOBAL TECHNOLOGIES COMPANY, COPYRIGHT © 2007 ACUMENT™ INTELLECTUAL PROPERTIES LLC. OPEN END, CELUS PLT®, CEL-NUT®, CLOSED END, TIGERBOLT®, LA COBRA, MULTIGRIP™ ARE REGISTERED TRADEMARKS OF CELUS® BRAND A RIVETKING® COMPANY. OPEN END, CAP RIVETS®, TAURUS, POLYGRIP, TRI-FOLD®, PH SERIES, GROOVED RIVETS, BULB-TITE®, GAV SYSTEMS®, PEEL, MEGAGRIP® ARE REGISTERED TRADEMARKS OF GESIPA® FASTENERS USA, INC. COPYRIGHT 2008®.

RivetKing® RivetNut - Product Line

<p>IKF SERIES® STANDARD RIVETNUT RIBBED BODY • LOW PROFILE HEAD</p> 	<p>IKR SERIES® STANDARD RIVETNUT • RIBBED BODY • REDUCED HEAD</p> 	<p>IRL SERIES™ STANDARD RIVETNUT • SMOOTH BODY • LARGE HEAD</p> 	<p>IRR SERIES™ STANDARD RIVETNUT • SMOOTH BODY • REDUCED HEAD</p> 	
<p>ISR SERIES™ STANDARD RIVETNUT • SWAGING • STRAIGHT KNURL</p> 	<p>ISN SERIES® STANDARD RIVETNUT • SWAGING • DIAMOND KNURL (FOR PLASTICS)</p> 	<p>IHF SERIES™ STANDARD RIVETNUT • HALF HEX BODY • LOW PROFILE HEAD</p> 	<p>NKL SERIES™ EUROPEAN STANDARD RIVETNUT • RIBBED BODY • LARGE HEAD</p> 	
<p>NKR SERIES™ EUROPEAN STANDARD RIVETNUT • RIBBED BODY • REDUCED HEAD</p> 	<p>NKC SERIES™ EUROPEAN STANDARD RIVETNUT • RIBBED BODY • COUNTERSUNK HEAD</p> 	<p>NSL SERIES™ EUROPEAN STANDARD RIVETNUTS • SMOOTH BODY • LARGE SERRATED HEAD</p> 	<p>NHL SERIES™ EUROPEAN STANDARD RIVETNUTS • FULL HEX BODY • LARGE HEAD</p> 	
<p>NHR SERIES™ EUROPEAN STANDARD RIVETNUT • FULL HEX BODY • REDUCED HEAD</p> 	<p>IPB SERIES™ STANDARD RIVETNUT • QUADRANUT • PRE-BULBED SHANK</p> 	<p>IPN SERIES™ STANDARD RIVETNUT • QUADRANUT • STRAIGHT SHANK</p> 	<p>JK SERIES™ STANDARD RIVETNUT • QUADRANUT • STAMPED</p> 	<p>JF SERIES™ STANDARD RIVETNUT • RUBBERNUT</p> 

SEMI TUBULAR RIVETS - ALL MATERIALS

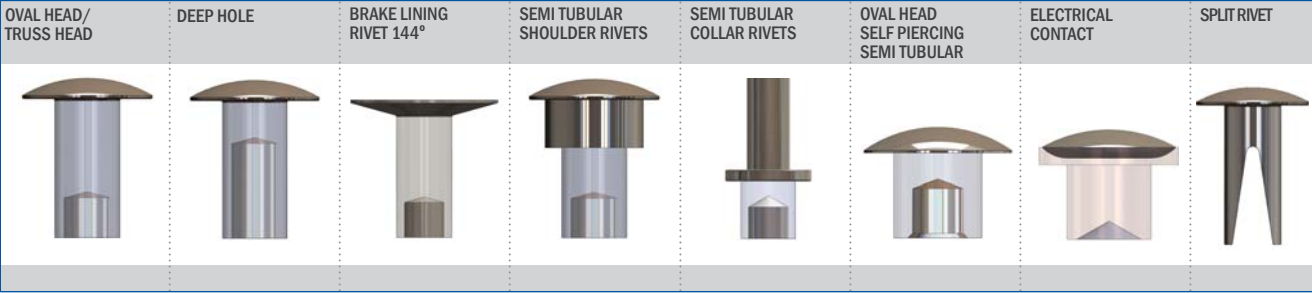

SOLID RIVETS: STEEL, BRASS, STAINLESS, COPPER AND MONEL

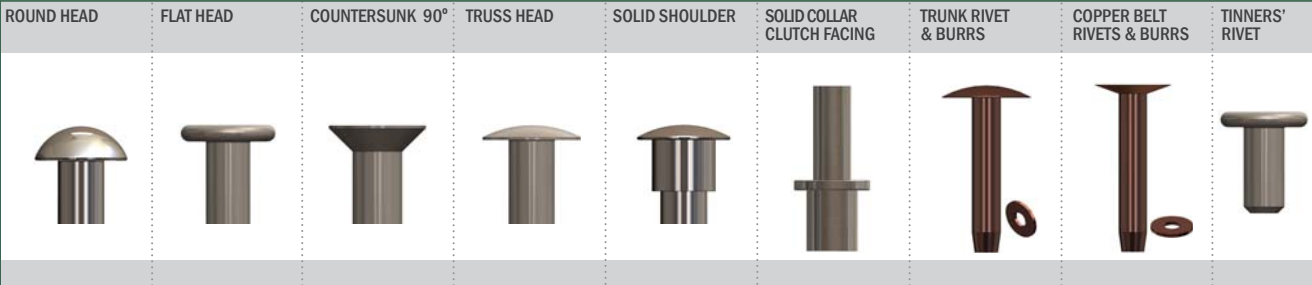

ALUMINUM RIVETS

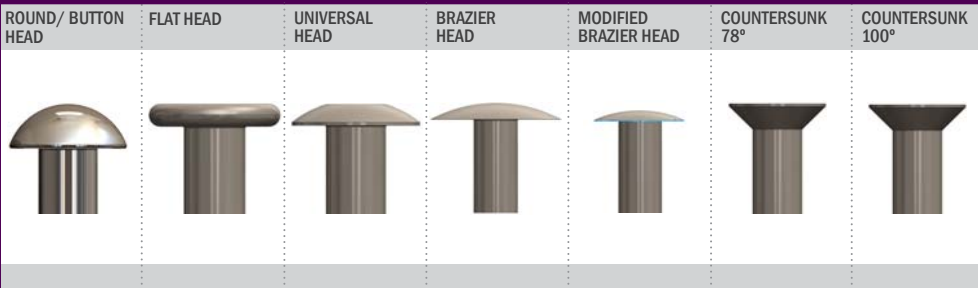

VARIOUS SPECIALS



RETAINER LOCK PINS

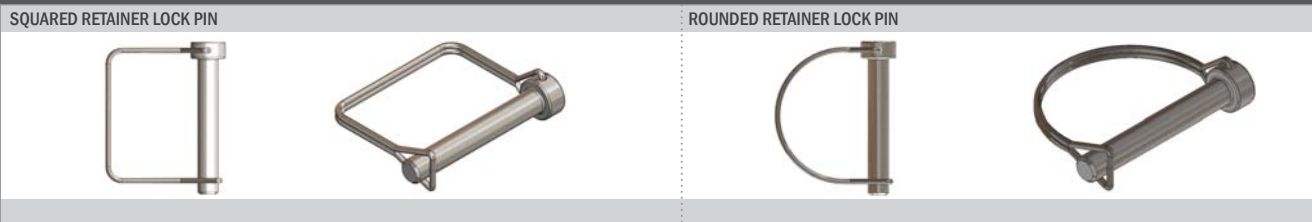

SETTING EQUIPMENT





WWW.RIVETKING.COM

**PHONE: 800.289.7483 FAX: 201.750.1050
200 PARIS AVENUE, NORTHVALE, NEW JERSEY 07647 USA**